



PT90E POSITIONER OPERATORS MANUAL



For further information, contact:

Voice: 561-691-5959; Fax 561-691-5983
email: Sales@Graflex.com

Graflex, Incorporated
15855 Assembly Loop, Suite 100
Jupiter, Florida 33478 USA

Date: January 28, 2014 Rev C

Graflex, Incorporated



Always on Target

Revision History

Original Publication Date Dec 14, 2011:

5/8/2012 Rev A: Clarified the meaning of “0” and “1” in Tables 2.3.4.2-2 and 2.3.4.2-3 on page 15.

5/24/2013: Rev B: The number of rear connectors has been increased from 2 to 4.

1/28/2014: Rev C: Corrected The Down Limit adjustment Para 3.3.1.3

For further information, contact:

Voice: 561-691-5959; Fax 561-691-5983
email: Sales@Graflex.com

Graflex, Incorporated
15855 Assembly Loop, Suite 100
Jupiter, Florida 33478 USA

Date Dec 14, 2011

Rev -

Graflex, Incorporated



Always on Target

IMPORTANT SAFETY INSTRUCTIONS

Read these operating instructions carefully before using the PT90E Positioner. Follow the safety instructions on the unit and the safety instructions listed below. Keep these operating instructions handy for future reference.

- 1) Read these instructions.
- 2) Keep these instructions.
- 3) Pay attention to all warnings.
- 4) Follow all instructions.
- 5) While considering the weight of the PT90E and its payload, select an installation location which is level and without unevenness. The location must be able to withstand the mounting weight and be stable. Failure to properly secure the unit may result in the product falling with possible damage to the unit, injury or even death.
- 6) Bolts for securing the unit are NOT provided with the PT90E. Select bolts which are sufficiently strong and made of a material which can withstand the outside environment.
- 7) The maximum payload of the PT90E is a 90 pound payload balanced and side mounted. An over the top payload is limited to 75 pounds at +/- 45 degrees.
- 8) The power must be off while installation or cable connections are underway.
- 9) Do not connect the serial I/O and power connector (P1) until checking for proper connections and the power being off.
- 10) Use water-proof connecting cables
- 11) Do Not turn the rotating parts of the PT90E by hand. This may cause excessive mechanical or electrical stress on the unit.
- 12) Make sure the elevation limits prevent the unit or its payload from contacting foreign objects.
- 13) Do not operate the control of the PT90E under any circumstances while installation is underway.

Dimensions below are in inches

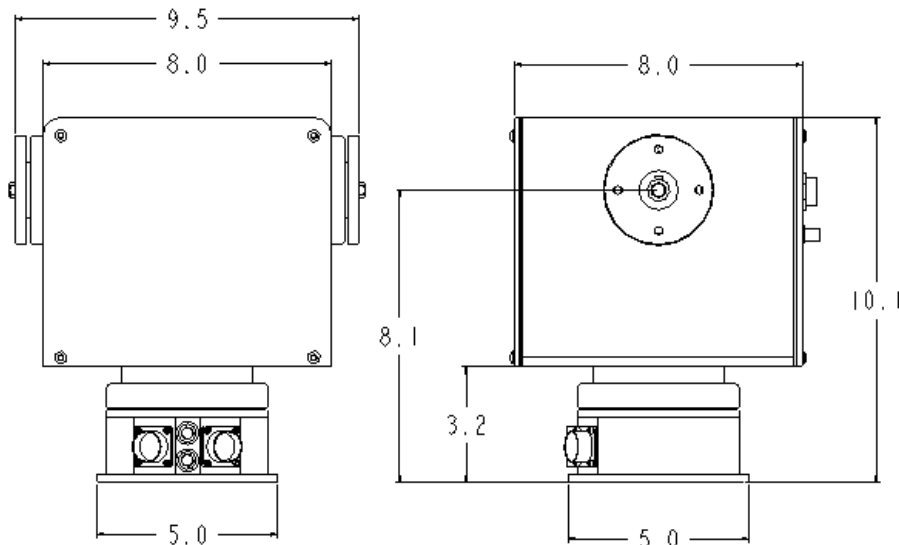

For further information, contact:

Voice: 561-691-5959; Fax 561-691-5983
email: Sales@Graflex.com

Graflex, Incorporated
15855 Assembly Loop, Suite 100
Jupiter, Florida 33478 USA

Graflex, Incorporated
 Always on Target

Table of Contents

1.0 Introduction	6
1.1 Safety Precautions	6
<i>1.1.1 Weight.....</i>	<i>6</i>
<i>1.1.2 Operating Safety.....</i>	<i>6</i>
1.2 Product Configurations	7
<i>1.2.1 Payload Mounting Configurations.....</i>	<i>7</i>
<i>1.2.2 Control and Power Interface.....</i>	<i>7</i>
1.2.3 Options	8
1.2.3.1 Standard Payload Mounts.....	8
1.2.3.2 Custom Payload Mounts	8
1.2.3.3 Slip Rings	8
1.2.3.4 Finish	8
1.2.3.5 Heater	8
1.2.3.6 Power Supplies	8
1.2.3.7 Shock Mounts.....	8
1.2.3.8 Protective Connector Caps	8
<i>1.2.4 Included in Package</i>	<i>8</i>
2.0 Location and Function of Parts	9
2.1 Base Plate Mounting	9
2.2 Base Connectors.....	9
<i>2.2.1 Base Connectors.....</i>	<i>9</i>
<i>2.2.2 Base Connector Wiring</i>	<i>10</i>
2.3 Upper Structure.....	11
<i>2.3.1 Elevation Mounting Hub</i>	<i>11</i>
<i>2.3.2 Payload Bracket Attachment to Elevation Hub.....</i>	<i>11</i>
<i>2.3.3 Sensor Connectors.....</i>	<i>11</i>
2.3.4 Key Internal Parts	13
2.3.4.1 Elevation Electrical Limits/Stops	13
2.3.4.2 Servo Board Setup Switches	14

For further information, contact:

Voice: 561-691-5959; Fax 561-691-5983
email: Sales@Graflex.com

Graflex, Incorporated
15855 Assembly Loop, Suite 100
Jupiter, Florida 33478 USA

Graflex, Incorporated
 Always on Target

Table of Contents-Continued

3.0 Installation	16
3.1 Basics	16
3.1.1 <i>Lifting Safety</i>	16
3.1.2 <i>Location of the PT90E</i>	16
3.1.3 <i>Obstructions</i>	16
3.1.4 <i>Tools</i>	16
3.1.5 <i>Install the PT90E</i>	16
3.1.6 <i>Initial Cabling</i>	16
3.2 Initial Test	17
3.2.1 <i>Initial Power Up</i>	17
3.3 Mechanical Adjustments	18
3.3.1 <i>Adjusting the Elevation Electrical Limit</i>	18
3.3.1.1 <i>Adjusting the Up Limit</i>	18
3.3.1.2 <i>Verify the Up Electrical Limit</i>	19
3.3.1.3 <i>Adjusting the Down Limit</i>	19
3.3.1.4 <i>Verifying the Down Electrical Limit</i>	19
3.3.2 <i>Mounting the Payload</i>	20
4.0 Basic Specifications	21
Appendix A: Drawings	22
Appendix A.1: Top Level Drawing	23
Appendix A.2: Elevation Drive Hub	24
Appendix A.3: Base Plate	25

For further information, contact:

Voice: 561-691-5959; Fax 561-691-5983
email: Sales@Graflex.com

Graflex, Incorporated
15855 Assembly Loop, Suite 100
Jupiter, Florida 33478 USA

Graflex, Incorporated
 Always on Target

1.0 Introduction

1.1 Safety Precautions

1.1.1 Weight

The PT90E weighs 26 pounds and caution must be exercised in handling the unit.

1.1.2 Operating Safety

Care must be taken before operating the PT90E to ensure there are no obstacles present that will prevent the unit from panning continuously. Care should also be taken to make sure any elevation obstacles are outside of the elevation electrical limits and elevation software limits. See Section 3.3.1 on setting elevation electrical limits.

Before operating the PT90E, be sure no individuals are near the unit. No one should be close to the unit when it is operating due to potential injury from being struck by the PT90E. The PT90E has speeds of up to 30 degrees/second and contacting a moving pan and tilt or payload is extremely hazardous.

For further information, contact:

Voice: 561-691-5959; Fax 561-691-5983
email: Sales@Graflex.com

Graflex, Incorporated
15855 Assembly Loop, Suite 100
Jupiter, Florida 33478 USA

Graflex, Incorporated
 Always on Target

1.2 Product Configurations

There are several product configurations covering payload mounting, Control and Power Interfaces and Options.

1.2.1 Payload Mounting Configurations

There are two standard payload mounting configurations; side mounted and over-the-top-mount. The advantage of the side mount is the ability to carry a heavier load than the over-the-top configuration.

A custom payload mount may also be designed by the user or the engineers at Graflex.

1.2.2 Control and Power Interface

The PT90E control and power enter the unit via connector P1 shown below in Figure 1.2.2. With power and serial interfaces entering on the same connector, there are two basic configurations available:

- **GUI Controlled:** External power supply providing +18 to +36 VDC of input power at 10 Amps maximum. The control being from a desktop or laptop computer. A Control GUI is supplied with the PT90E for computer control. The GUI is described in more detail in the “Graflex PT90E GUI V6.2 Manual” Operating Manual for the standard PT90E or the “Graflex PT90EA GUI V6.2 Manual” Operating Manual for the specially modified PT90EA software.
- **Control Panel Controlled:** External power supply providing +18 to +36 VDC of input power at 10 Amps maximum. A control panel is used to control the operation of the PT90E. The commands from the control panel to the PT90E are the same as those from the GUI and the GUI is a helpful tool in checking out a control panel design. The commands are described in “PT90E Interface Protocol Manual”.

Figure 1.2.2



For further information, contact:

Voice: 561-691-5959; Fax 561-691-5983
email: Sales@Graflex.com

Graflex, Incorporated
15855 Assembly Loop, Suite 100
Jupiter, Florida 33478 USA

Graflex, Incorporated
 Always on Target

1.2.3 Options

Several options are available for the PT90E and they are listed below.

1.2.3.1 Standard Payload Mounts: As discussed in the previous section, side and over-the-top mounts are optionally available from Graflex.

1.2.3.2 Custom Payload Mounts: The payload mounting surfaces are hubs located on each side of the PT90E as shown in the Elevation Hub drawing. See the Elevation Hub drawing in Appendix A.2. The user or Graflex may design a custom payload mount per the user requirements.

1.2.3.3 Slip Rings: The PT90E comes with a standard slip ring package of which 15 are 2 Amp rings that are available as “Pass Thru” rings for customer use.

1.2.3.4 Finish: There are several alternative finishes. The standard PT90E comes with a white powder coat. Other finishes include: black anodize, white paint, tan paint, green paint or a customer specified finish.

1.2.3.5 Heater: An optional thermostatically controlled heater is available. For extremely cold temperatures, an exterior blanket is also available.

1.2.3.6 Power Supplies: Optional indoor and outdoor power supplies are available. Contact Graflex for details.

1.2.3.7 Shock Mounts: Shock and vibration isolation mounts are available for high shock and vibration environments. The shock and vibration design is dependent upon the user requirements. Contact Graflex for additional details.

1.2.3.8 Protective Connector Caps: Available as an option.

1.2.4 Included in Package

Included in the PT90E package are the following items:

- PT90E Positioner
- Operators Manual
- GUI: A software program to allow the PT90E to be controlled by a computer.

For further information, contact:

Voice: 561-691-5959; Fax 561-691-5983
email: Sales@Graflex.com

Graflex, Incorporated
15855 Assembly Loop, Suite 100
Jupiter, Florida 33478 USA

Graflex, Incorporated
 Always on Target

2.0 Location and Function of Parts

2.1 Base Plate Mounting

The location and spacing of the four mounting holes is shown in Appendix A.3. There are four equally spaced mounting holes which are designed to accept 1/4-20 inch mounting bolts. Do not use smaller diameter mounting hardware.

Make sure the mounting surface is adequately strong to support the 26 pound weight of the PT90E and the additional weight of up to 40 pounds of payload. The mounting hardware must be of a material strong enough to withstand the strong motion of the PT90E without failing.

2.2 Base Connectors

2.2.1 Base Connector Location and Part Numbers

The base of the PT90E contains a connector plate with five connectors. These connectors provide the DC power input, the serial control signal, the pass through connections and the BNC connectors for video output. The location of each connector is shown in the Figure 2.2.1 below.

Table 2.2.1 below lists the function and connector part number and mating connector for each of the connectors.

Table 2.2.1 Base Connectors

Connector #	Description	Part Number	Mating Connector
P1	Power & Serial Control Input	PT02E-14-12P	PT06E-14-12S
P2	Pass Through	PT02E-14-19P	PT06E-14-19S
J1, J2	BNC Video	31-10	BNC

Figure 2.2.1 Base Connectors

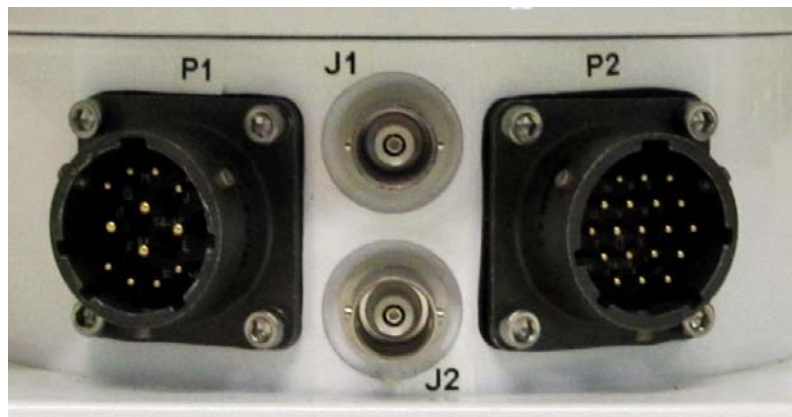

For further information, contact:

Voice: 561-691-5959; Fax 561-691-5983
email: Sales@Graflex.com

Graflex, Incorporated
15855 Assembly Loop, Suite 100
Jupiter, Florida 33478 USA

Graflex, Incorporated
 Always on Target

2.2.2 Base Connector Wiring

Table 2.2.2-1 provides the wiring from the P1 input connector to the slip ring. Table 2.2.2-2 provides the wiring from the pass through connector, P2, J1 and J2 to the slip ring.

Table 2.2.2-1 P1 Standard Slip Ring Wiring

Pin #	Name	Amps	S/R No.	S/R Color
A	TX+	2	1	BLK
B	TX-	2	2	BRN
C	GND	2	3	RED
D	RCV+	2	4	ORG
E	RCV-	2	5	YEL
J	+24 VDC	10	25	WHT
K	+24 VDC	10	26	BRN
L	GND	10	27	RED
M	GND	10	28	ORG

Note: P1 Pins F, G and H are not



Table 2.2.2-2 P2 , J1 & J2 Slip Ring Wiring

Pin #	Connector	Amps	S/R No.	S/R Color
A	P2	2	6	GRN
B	P2	2	7	BLU
C	P2	2	8	VIO
D	P2	2	9	GRY
E	P2	2	10	WHT
F	P2	2	11	W/BLK
G	P2	2	12	W/BRN
H	P2	2	13	W/RED
1	J1 Vid	2	14	W/ORA
2	J1 Gnd	2	15	W/YEL
J	P2	2	16	W/GRN
K	P2	2	17	W/BLU
L	P2	2	18	W/VIO
M	P2	2	19	W/GRY
N	P2	2	20	W/BK/BR
P	P2	2	21	W/BK/RD
R	P2	2	22	W/BK/OR
1	J2 Vid	2	23	W/BK/YE
2	J2 Gnd	2	24	W/BK/GN

Note: P2 Pins S, T, U, V are not used.

For further information, contact:

Voice: 561-691-5959; Fax 561-691-5983
email: Sales@Graflex.com

Graflex, Incorporated
15855 Assembly Loop, Suite 100
Jupiter, Florida 33478 USA

Graflex, Incorporated
 Always on Target

2.3 Upper Structure

2.3.1 Elevation Mounting Hub

On either side of the PT90E are the mounting hubs for attaching payload brackets. Figure 2.3.1 to the right identifies the right elevation hub and the elevation bearing housing. The elevation hub rotates on the elevation shaft causing a payload move accordingly. When the PT90E is delivered, the elevation position is at 0 degrees in elevation.

Elevation Hub

Elevation Bearing Housing

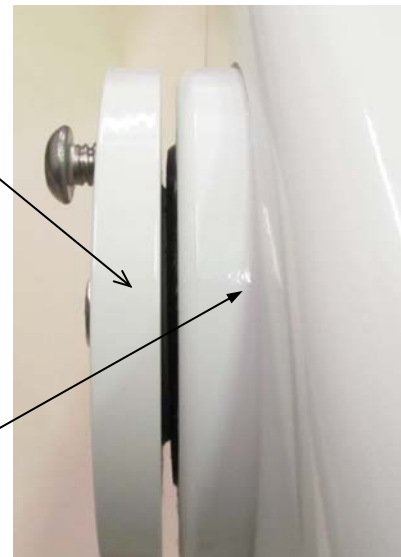

Figure 2.3.1 Elevation Hub & Bearing Housing

2.3.2 Payload Bracket Attachment to Elevation Mounting Hubs

The payload mounting brackets should be mounted to the Elevation hubs with 1/4-20 bolts. These bolts must not protrude through the elevation mounting hub. If the bolts protrude enough to touch the elevation bearing housing, damage may occur to the housing, the hub or both.

The Elevation Hub drawing is shown in Appendix A.2 This drawing defines the exact hole locations and can be used to design a custom bracket.

2.3.3 Sensor Connectors

The top row of 2 connectors and the bottom row of 2 connectors shown in Figure 2.3.3 are the sensor connectors. Each connector may be specially wired to a customer's requirement. The customer wiring options include the following.

- Pass through of only signals from P2 on the base of the PT90E.
- Use of the internal +24VDC for power in addition to the P2 signals.
- Use of Video signal connectors J1 and J2 on the base of the in addition to P2 signals.

The connectors and their mating connectors are listed in Table 2.3.3.

For further information, contact:

Voice: 561-691-5959; Fax 561-691-5983
email: Sales@Graflex.com

Graflex, Incorporated
15855 Assembly Loop, Suite 100
Jupiter, Florida 33478 USA

Graflex, Incorporated
 Always on Target

Figure 2.3.3 Rear Panel Connectors

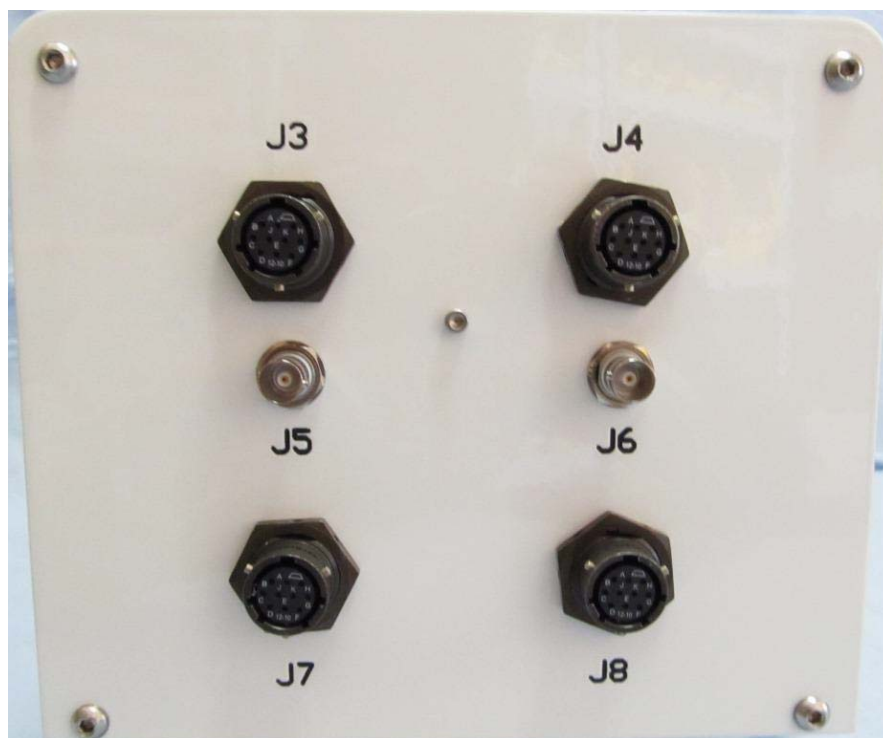



Table 2.3.3 Sensor Connectors and their Mates

Connector #	Description	Part Number	Mating Connector
J3	Sensor Connector A	PT07-12-10S	PT06-12-10P
J4	Sensor Connector B	PT07-12-10S	PT06-12-10P
J5	BNC Video	UBJ21	BNC
J6	BNC Video	UBJ21	BNC
J7	Sensor Connector C	PT07-12-10S	PT06-12-10P
J8	Sensor Connector D	PT07-12-10S	PT06-12-10P

For further information, contact:

Voice: 561-691-5959; Fax 561-691-5983
email: Sales@Graflex.com

Graflex, Incorporated
15855 Assembly Loop, Suite 100
Jupiter, Florida 33478 USA

Graflex, Incorporated
 Always on Target

2.3.4 Key Internal Part Locations

There are two key internal part locations that may require user access during the initial set-up of the system. They are the two Elevation Electrical Limits/Stops and the Setup Switches located on the Servo Board.

2.3.4.1 Elevation Electrical Limits/Stops

There are two Elevation Electrical Limit wheels located behind the rear panel of the PT90E. Figure 2.3.4.1-1 shows the rear panel access.

The two limit wheels are located in the top left portion of the PT90E as viewed from the rear. Figure 2.3.4.1-2 illustrates the location of the Up and Down Limit wheels.

Figure 2.3.4.1-1 Rear Panel Access

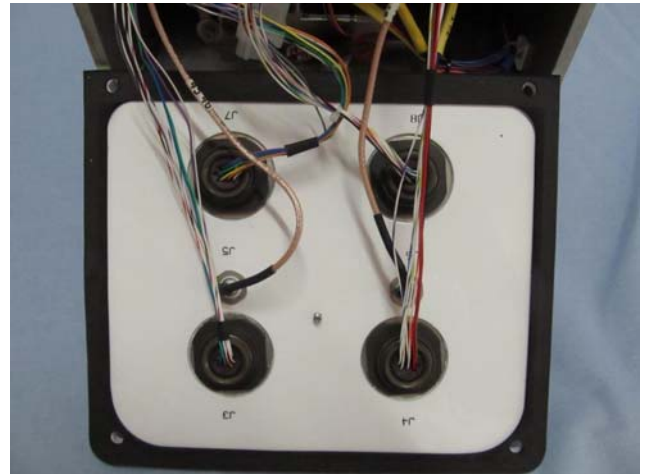
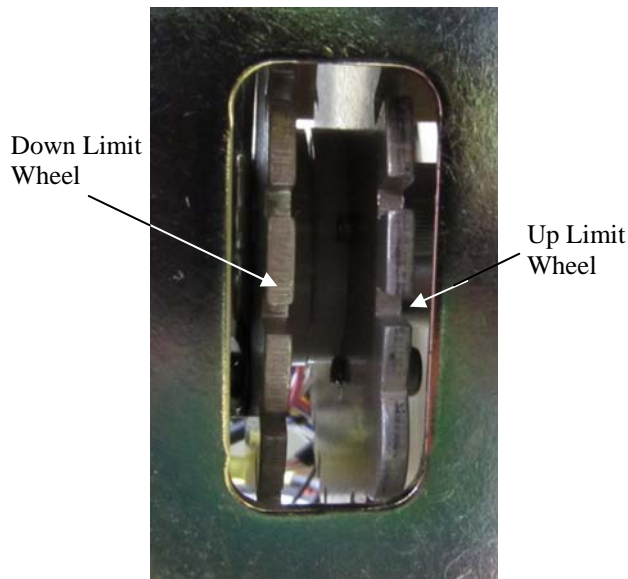

Figure 2.3.4.1-2 Up and Down Limit



The Elevation Electrical Limits Wheels are to be used as a safety precaution against contacting external objects that may damage or be damaged by the elevation travel of the payload. Software limits are set to meet operational constraints and are always set within the electrical limit envelope.

More detail is provided on the setting of the electrical limits in paragraph 3.3.1

For further information, contact:

Voice: 561-691-5959; Fax 561-691-5983
email: Sales@Graflex.com

Graflex, Incorporated
15855 Assembly Loop, Suite 100
Jupiter, Florida 33478 USA

Graflex, Incorporated
 Always on Target

2.3.4.2 Servo Board Setup Switches

The setup switches are located on the Servo Board which is located on the inside of the front cover.

To gain access to the Servo Board, the front cover must be removed to reveal the Servo Board. Figure 2.3.4.2 shows the Servo Board and the insert photo below it shows the PT90E setup switches. Setup Switches 1 and 2 are used to select the input signal interface. Both Comm1 and Comm2 are set as RS-232 as the factory default. The default settings are shown in bold.

Setup Switch 3 is used to select 5 msec or 10 msec loop rate for the PT90EA version of the PT90E. Switches 4 and 5 are used to select the BAUD rate and switches 6, 7, and 8 are used to select the protocol. Table 2.3.4.2-1 below and Table 2.3.4.2-2 on the next page show the switches for the PT90EA version.

Figure 2.3.4.2 Servo Board



10 msec, 38400 BAUD

5 msec, 57600 BAUD



Table 2.3.4.2-1 Setup Switches

Switch	Description
1	On : The RS-232 Communications mode is selected for Comm 1 Off: The RS-422 Communications mode is selected for Comm 1
2	On : The RS-232 Communications mode is selected for Comm 2: Not Used Off: The RS-422 Communications mode is selected for Comm 2: Not Used
3	Loop Time Select(see Table 2.3.4.2-2)
4	Baud Rate Selection bit(see Table 2.3.4.2-2)
5	Baud Rate Selection bit(see Table 2.3.4.2-2)
6	Protocol Selection bit(see Table 2.3.4.2-3)
7	Protocol Selection bit(see Table 2.3.4.2-3)
8	Protocol Selection bit(see Table 2.3.4.2-3)

For further information, contact:

Voice: 561-691-5959; Fax 561-691-5983
email: Sales@Graflex.com

Graflex, Incorporated
15855 Assembly Loop, Suite 100
Jupiter, Florida 33478 USA

Graflex, Incorporated
 Always on Target

Table 2.3.4.2-2 Baud Rate Selection Table

DSW3	DSW4	DSW5	Baud Rate
1	x	x	10 msec loop time
0	x	x	5 msec loop time
x	1	1	19200
x	0	0	38400
x	0	1	57600
x	1	0	115200

Note: a “1” is equivalent to the switch being “OFF” and the a “0” is equivalent to the switch being “ON”. This is true for all DSW settings. “x” means do not care.

Table 2.3.4.2-3 Protocol Selection Table

DSW6	DSW7	DSW8	Protocol
0	0	0	Auto Select *
1	0	0	DPT 220
0	1	0	PT75/PT150
1	1	0	DPT115/DPT 130
0	0	1	Pelco D
1	0	1	Special

* Auto Select automatically selects the protocol from all of the listed protocols except the Pelco D protocol. Pelco D must be selected manually. If only a single protocol will be used, it is advisable to manually select it with the Setup Switches.

Note: The Bold/highlighted rows are the default settings. Please note that the PT75/PT150 is selected as the default setting. DO NOT CHANGE.

For further information, contact:

Voice: 561-691-5959; Fax 561-691-5983
email: Sales@Graflex.com

Graflex, Incorporated
15855 Assembly Loop, Suite 100
Jupiter, Florida 33478 USA

Graflex, Incorporated
 Always on Target

3.0 Installation

3.1 Basics

3.1.1 Lifting Safety

Be careful when removing the PT90E from its packing and when moving it to a cart or the installation location. It weighs 26 pounds and caution must be used when lifting to avoid injury.

3.1.2 Location of the PT90E

While considering the weight of the PT90E and its payload, ensure the installation location is level and without unevenness. The location must be able to withstand the mounting weight and be stable.

3.1.3 Obstructions

Make sure there are no azimuth obstructions and there is adequate clearance for the payload to rotate freely in azimuth. Any elevation obstructions must be outside the electrical limits. Paragraph 3.3.1 will explain how to adjust the electrical limits.

3.1.4 Tools

The following tools are required for the installation of the PT90E.

- 3/16 inch Ball End Hex Wrench, Allen Wrench or T-Handle Ball End Hex wrench to remove and install the 1/4-20 bolts used on the elevation hub.
- 1/8 inch Ball End Hex Wrench, Allen Wrench or T-Handle Ball End Hex wrench to remove the screws securing the PT90E front panel.

3.1.5 Install the PT90E

Locate the rear of the PT90E. This is where the base connector plate is located. The sensor connectors should be in the same orientation as the base connectors. All connectors face the rear when the PT90E is pointed to 0.0 degrees in azimuth. Position the PT90E over the base mounting hole pattern shown in Appendix A.3 and secure the PT90E with 1/4-20 inch bolts.

3.1.6 Initial Cabling

Make sure the power supply is in the OFF position. Connect the power/serial control cable to base connector P1. Make sure the control device is not connected or if connected, not powered up. We want to power up the PT90E without any control device operational.

For
further information, contact:

Voice: 561-691-5959; Fax 561-691-5983

Graflex, Incorporated
15855 Assembly Loop, Suite 100

Graflex, Incorporated



Always on Target

3.2 Initial Test

3.2.1 Initial Power Up

With the power OFF, connect the control source and apply power to the control source. Turn the PT90E power ON. The control source is now in command of the PT90E.

Perform simple commands to insure basic Positioner operation. Move the PT90E up, down, left and right a small amount. If the controller displays position feedback, there should be position change in accordance with the Positioner movement.

Move the azimuth until the base connectors and the sensor connectors are both together. This position should be approximately 0 degrees azimuth. Command the elevation to move to the 0 elevation position. The elevation axis is now positioned at approximately 0 degrees in elevation. Note: The PT90E is delivered with the elevation and azimuth positions being at 0 in both axes.

For further information, contact:

Voice: 561-691-5959; Fax 561-691-5983
email: Sales@Graflex.com

Graflex, Incorporated
15855 Assembly Loop, Suite 100
Jupiter, Florida 33478 USA

Graflex, Incorporated
 Always on Target

3.3 Mechanical Adjustments

If the factory set elevation electrical limits of +45 degrees and -45 degrees are where desired for your installation, then skip the following paragraphs and go directly to paragraph 3.3.2 “Mounting the Payload”.

3.3.1 Adjusting the Elevation Electrical Limits

To get access to the Limit Wheels, the front cover must be removed. Before removing the cover, verify the following:

- The power is OFF.
- There is no payload attached to the payload mounting brackets.

Now carefully remove front cover with the 1/8 inch Allen wrench. The back-side of the front cover is where the Servo Drive board is located. Be careful to secure the front panel before making the Limit Wheel adjustments.

Turn the power ON. Move the PT90E up with the control source until it can no longer move any further. This is the UP limit position. If this position needs to be changed, go to paragraph 3.3.1.1 “Adjusting the Up Limit”.

Move the PT90E down with the control source until it can no longer move any further. This is the DOWN limit position. If this position needs to be changed, go to paragraph 3.3.1.3 “Adjusting the Down Limit”.

3.3.1.1 Adjusting the Up Limit

Carefully move the PT90E elevation axis with the control source until the desired up elevation limit position is reached or the PT90E will no longer move (It is in the up stop). Figure 3.3.1.1 shows the up limit wheel.

To adjust the Up stop for a higher elevation up stop location, use a flat blade screwdriver. Place the screwdriver in one of the up wheel slots and push it DOWN. This will increase the Up limit angle.

To adjust the Up stop for a lower elevation up stop location, place the screwdriver in one of the up wheel slots and push it UP. This will decrease the Up limit angle.

Figure 3.3.1.1 Up Limit Wheel



For further information, contact:

Voice: 561-691-5959; Fax 561-691-5983
email: Sales@Graflex.com

Graflex, Incorporated
15855 Assembly Loop, Suite 100
Jupiter, Florida 33478 USA

Graflex, Incorporated
 Always on Target

3.3.1 2 Verify the Up Electrical Limits Position

To verify the electrical up limit position, position the elevation axis up until it contacts the up stop. The up motion should now be disabled and only a down motion allowed. The new electrical up limit should be displayed on the control source position feedback display.

3.3.1 3 Adjusting the Down Limit

Carefully move the PT90E elevation axis with the control source until the desired down elevation limit position is reached or the PT90E will no longer move (It is in the down stop). Figure 3.3.1.3 shows the down limit wheel

To adjust the Down Limit Wheel for a higher elevation down stop location, use a flat blade screwdriver. Place the screwdriver in one of the down wheel slots and push it UP. This will increase the Down limit angle for a larger down movement.

To adjust the Down Limit Wheel for a lower elevation down stop location, place the screwdriver in one of the down wheel slots and push it Down. This will decrease the Down limit angle and reduce the down movement.

Figure 3.3.1.3 Down Limit Wheel

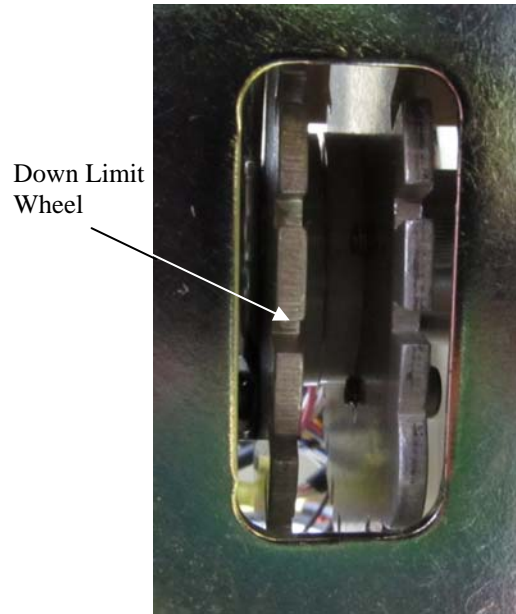

3.3.1 4 Verify the Down Electrical Limits Position

To verify the electrical down limit position, position the elevation axis down until it contacts the down stop. The down motion should now be disabled and only an upward motion allowed. The new electrical down limit should be displayed on the control source position feedback display.

For further information, contact:

Voice: 561-691-5959; Fax 561-691-5983
email: Sales@Graflex.com

Graflex, Incorporated
15855 Assembly Loop, Suite 100
Jupiter, Florida 33478 USA

Graflex, Incorporated
 Always on Target

3.3.2 Mounting the Payload

Before actually mounting the sensor payload to the payload mounting brackets, do the following:

- Make sure the elevation axis is at 0 degrees and the payload mounting brackets are level with the ground. If it is not, use the control source to level the payload mounting bracket.
- Turn the power OFF
- Make sure the payload mounting brackets are securely fastened to the PT90E.

Mounting the sensors requires user supplied hardware and tools. A few tips to make installation easier and operation more efficient are listed below:

- Locate sensors on both sides of the PT90E, if using side mounts.
- Determine the horizontal center of gravity of each sensor and balance the load forward and aft as well as possible.
- Balance the weight between the two side mounts as well as possible.
- Check for azimuth obstructions and eliminate any found.
- Make sure the elevation electrical limits are adequately adjusted. If not, readjust the up and/or down limits.

You are now ready to connect the sensor connectors and prepare for operation.

For further information, contact:

Voice: 561-691-5959; Fax 561-691-5983
email: Sales@Graflex.com

Graflex, Incorporated
15855 Assembly Loop, Suite 100
Jupiter, Florida 33478 USA

Graflex, Incorporated
 Always on Target

4.0 Basic Specifications

Characteristics:

Dimensions	9.5”(w) x 8.0” (d) x 10.1” (h)
Weight	26 Pounds
Base Dimension.....	5” Square
Construction	Aluminum and Stainless Steel
Exterior Color.....	Anodized or Painted
Backlash	Negligible and adjustable
Tilt Limits.....	Adjustable over 200 degree range
Drive Motor	DC Brush

Electrical:

Travel	
Pan	Continuous
Tilt	+100 to -100 adjustable limits
Feedback.....	11 Bit On-Axis Encoder
Max Speed	
Pan	30 Degrees/sec
Tilt	10 Degrees/sec
Resolution.....	0.044 Degrees
Repeatability.....	0.088 Degrees
Accuracy.....	0.10 Degrees
Voltage	+18 VDC to +36 VDC
Power	
w/o Heater	25W nominal, 75 Watts Max
w/Heater	75W nominal, 125Watts Max

Communications:

Interface:.....	RS-232 or RS-422
Sensor Pass Through	15 @ 2 Amp slip rings
Video	2
Control.....	GUI supplied

Options:

Finish	Multiple colors and finishes
Payload Mount	Side or Over the Top
Heaters.....	Blanket, Heaters & Thermostat
Shock Mount	Contact Factory

Environmental:

Operating Temperature.....	0 to 70 degrees C (w/o heater)
Ingress Protection	IP66
Shock	Mil 810E: Proc 516.4

For further information, contact:

Voice: 561-691-5959; Fax 561-691-5983
email: Sales@Graflex.com

Graflex, Incorporated
15855 Assembly Loop, Suite 100
Jupiter, Florida 33478 USA

Graflex, Incorporated
 Always on Target

Appendix A

A.1 Top Level Drawing

A.2 Elevation Drive Hub

A.3 Base Plate

For further information, contact:

Voice: 561-691-5959; Fax 561-691-5983
email: Sales@Graflex.com

Graflex, Incorporated
15855 Assembly Loop, Suite 100
Jupiter, Florida 33478 USA

Graflex, Incorporated
 Always on Target

A.1 Top Level Drawing

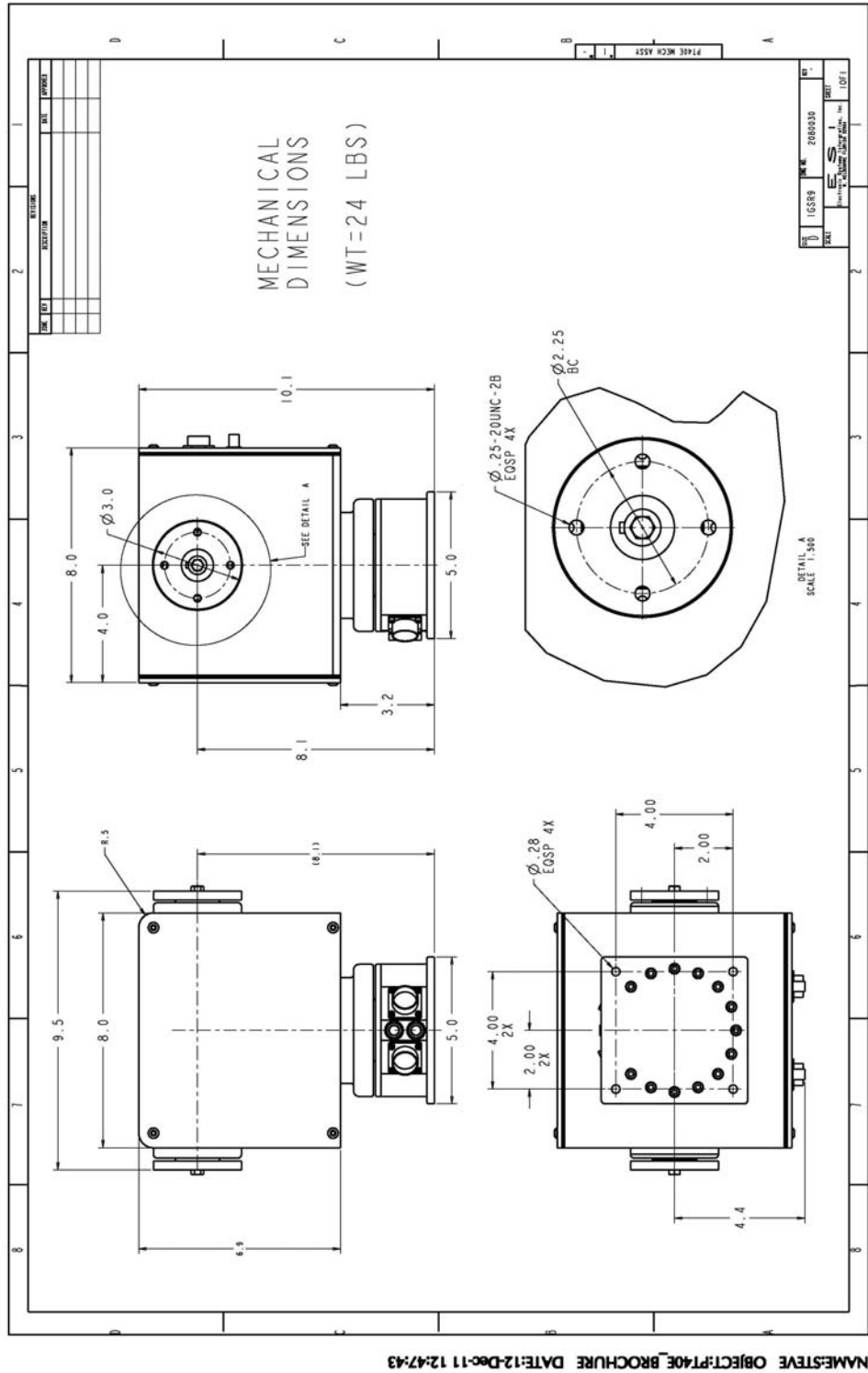

For further information, contact:

Voice: 561-691-5959; Fax 561-691-5983
email: Sales@Graflex.com

Graflex, Incorporated
15855 Assembly Loop, Suite 100
Jupiter, Florida 33478 USA

Graflex, Incorporated
Always on Target



A.2 Elevation Drive Hub

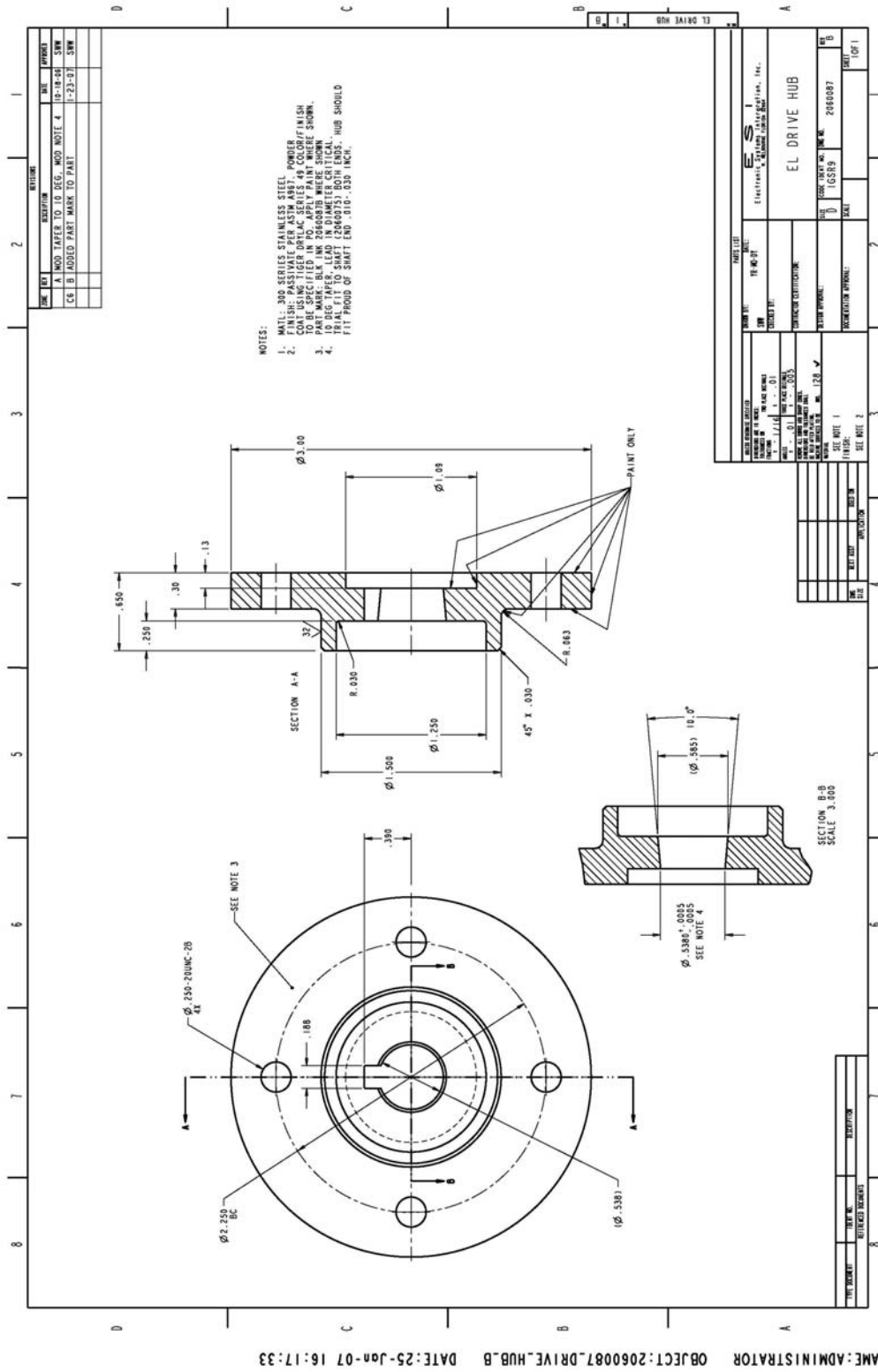

NAME: ADMINISTRATOR OBJECT: 2060087_DRIVE_HUB_B DATE: 25-Jun-07 16:17:33

For further information, contact:

Voice: 561-691-5959; Fax 561-691-5983
email: Sales@Graflex.com

Graflex, Incorporated
15855 Assembly Loop, Suite 100
Jupiter, Florida 33478 USA

Graflex, Incorporated
 Always on Target

A.3 Base Plate

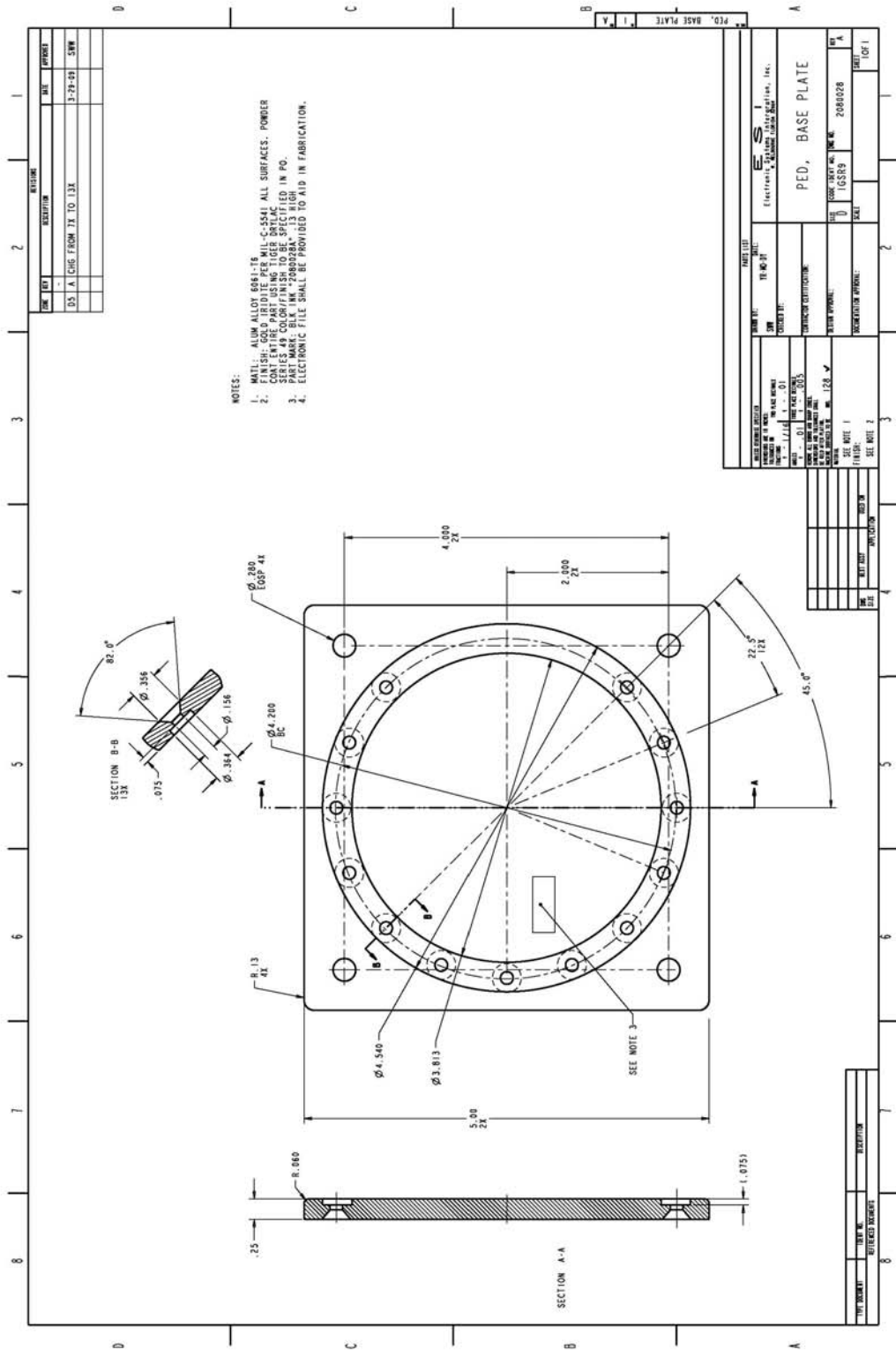

NAME: ADMINISTRATOR OBJECT: 2080028A PLATE BASE DATE: 29-Mar-09 12:34:42

For further information, contact:

Voice: 561-691-5959; Fax 561-691-5983
 email: Sales@Graflex.com

Graflex, Incorporated
 15855 Assembly Loop, Suite 100
 Jupiter, Florida 33478 USA

